

GHIBLI SAUNA

150x120 H 215

SAUNAVITA®
calore naturale

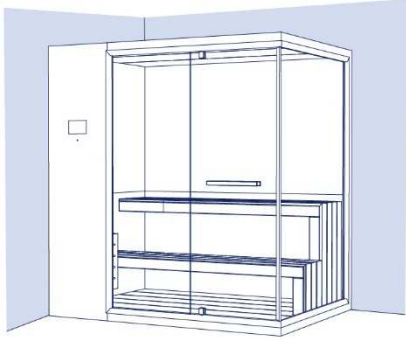

The overall dimension values are expressed in centimetres.
The actual dimensions may vary by ± 1 cm.

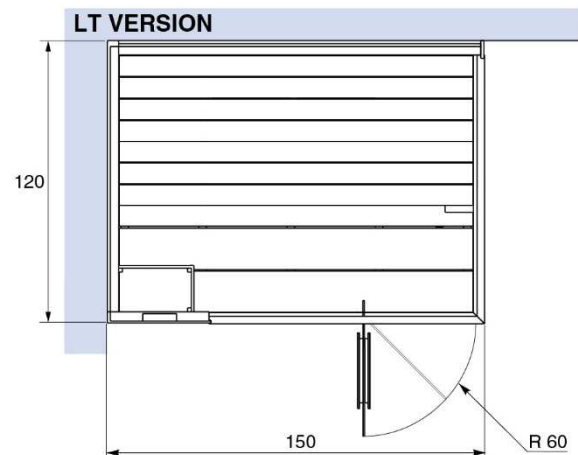
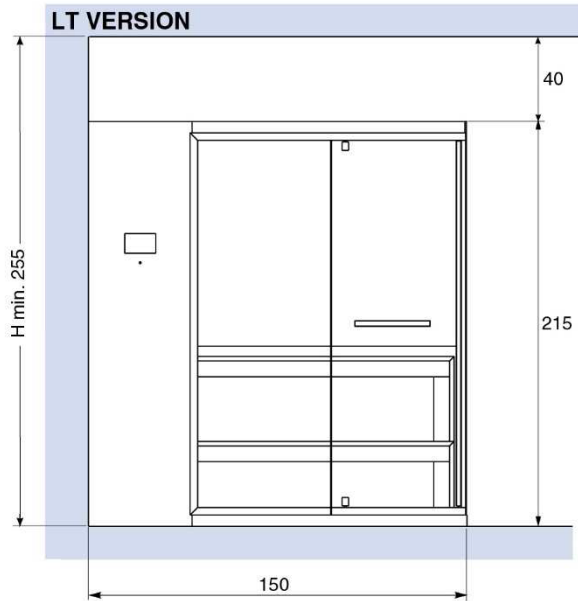

Electrical provisions

KEY:

- A - Power cable outlet area length min. 2 m (SINGLE PHASE OR THREE PHASE);
- B - Electrical wiring box;
- C - Control panel;
- D - Space required to install the sauna;

LT VERSION

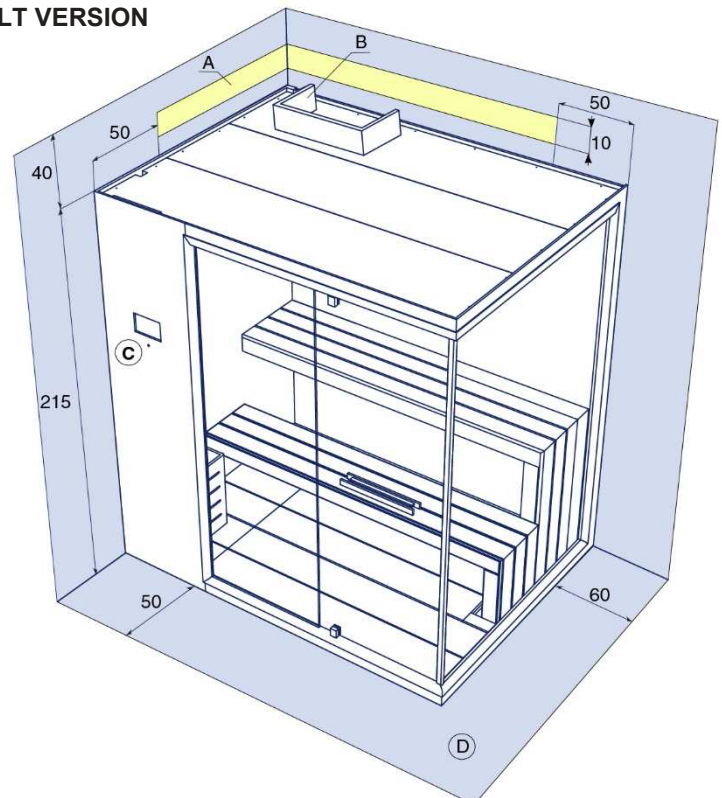

Ghibli Sauna LT corner installation.
For RT corner installation the connections are specular

The minimum height of the wall tiles without protrusions is equal to the height of the stall.
On the walls there cannot be any greca or quarter round decorative patterns.

GHIBLI SAUNA 150x120 H.215

SAUNA SAFETY:

SAUNA VITA saunas are built and tested in compliance with European standards in order to guarantee maximum safety for the user.

CONNECTION TO THE ELECTRICAL MAINS:

- The electrical connection must be carried out by qualified personnel;
- The electrical system in the facilities must comply with the CEI 64.8 standards protected by a differential switch;
- The differential switch must have rated operating current no greater than 30 mA and a minimum contact opening of 3 mm. The switch must be placed in the "closed" ("on") position only for the time the equipment is used, after which it must be returned to the "open" ("off") position. The switch must not be accessible by the person using the equipment;
- The earthing system must be efficient and in compliance with CEI standards;
- The electrical connection of the equipment must be carried out in a fixed and permanent way;
- If the sauna is installed in a bath facility, follow the instructions below;
- The switch must be located outside of areas 1, 2 and 3 with a water protection grade of IPX4 (CEI 64-8/7).

Electrical Characteristics

ELECTRICAL CHARACTERISTICS:	RESISTANCES	Volts	A	Kw	Hz	MAXIMUM TEMPERATURE
GHIBLI SAUNA	3 x 1.5 Kw	230	21	4.5	50	100 °C
		400	7	4.5	50	

GRUPPO GEROMIN S.r.l.

Via I° Maggio n°5 (zona Industriale)

30029 San Stino di Livenza VE

Tel. +39 0421 312249 / +39 0421 312250

http: www.gruppogeromin.com - email: info@gruppogeromin.com